

Stainless steel Cylinders Series 90

1

Single and double-acting magnetic (DIN/ISO 6431)
 ø32, 40, 50, 63, 80, 100 and 125 cushioned



- » DIN/ISO 6431
- » Clean design
- » Stainless steel AISI 316



Stainless steel cylinders Series 90 ø 32, 40, 50, 63, 80, 100 and 125 have been designed to comply with the sizes of standard DIN/ISO 6431. These cylinders are suitable for use in harsh environmental conditions as in the off-shore, naval, pharmaceutical, nuclear and food industries.

A permanent magnet is mounted on the piston in these cylinders. The position of the cylinder is obtained by the magnetic proximity switches mounted on the cylinder. This series of cylinders is normally equipped with adjustable end-stroke cushioning. In addition these cylinders are equipped with a mechanical cushioning in order to make the impact of the piston less noisy as it reaches the end of the stroke.

GENERAL DATA

Type of construction	with tie-rods
Operation	single-acting or double-acting
Materials	end block, tube, tie-rods and rod = stainless steel AISI 316 (SS 2343); seals = NBR
Type of mounting	front and rear flange - feet front and rear bracket - swivel combination
Stroke	standard (see table) / min-max: all bores 25-800 mm
Operating temperature	0°C + 80°C (with dry air - 20°C)
Operating pressure	1 ÷ 10 bar
Speed	10 ÷ 1000 mm/sec (no load)
Fluid	clean air, without lubrication
	* If lubricated air is used, it is recommended to use oil ISOVG32. Once applied, lubrication should never be interrupted.

STANDARD STROKES FOR DOUBLE-ACTING CYLINDER SERIES 90

✕ = Double-acting 90M2A

∅	25	50	75	80	100	125	150	160	200	250	300	320	400	500
32	✕	✕	✕	✕	✕	✕	✕	✕	✕	✕	✕	✕	✕	✕
40	✕	✕	✕	✕	✕	✕	✕	✕	✕	✕	✕	✕	✕	✕
50	✕	✕	✕	✕	✕	✕	✕	✕	✕	✕	✕	✕	✕	✕
63	✕	✕	✕	✕	✕	✕	✕	✕	✕	✕	✕	✕	✕	✕
80	✕	✕	✕	✕	✕	✕	✕	✕	✕	✕	✕	✕	✕	✕
100	✕	✕	✕	✕	✕	✕	✕	✕	✕	✕	✕	✕	✕	✕
125		✕	✕	✕	✕	✕	✕	✕	✕	✕	✕	✕	✕	✕

CODING EXAMPLE

90	M	2	A	050	A	0200	
----	---	---	---	-----	---	------	--

90	SERIES
M	VERSION M = standard, magnetic
2	OPERATION 1 = single-acting (front spring) 2 = double-acting (front and rear cush.) 6 = double-acting (through-rod with front and rear cushions)
A	MATERIALS A = stainless steel AISI 316 (SS 2343), seals in NBR V = stainless steel AISI 316 (SS 2343), all seals in FKM
050	BORE (∅): 032 = 32 mm 040 = 40 mm 050 = 50 mm 063 = 63 mm 080 = 80 mm 100 = 100 mm 125 = 125 mm
A	TYPE OF DESIGN A = standard
0200	STROKE see table
	= standard V = rod seals in FKM

STAINLESS STEEL CYLINDERS SERIES 90



Piston rod lock nut Mod. U-90



Rear trunnion, female Mod. C



Rod fork end Mod. G-90



Front and rear flange Mod. D



Foot mount Mod. B



90° male trunnion Mod. ZC-90



Swivel ball joint Mod. GA-90



All accessories are supplied separately, except for the piston rod lock nut Mod. U



Rear trunnion, male Mod. L



Clevis pin Mod. S-90



Combination Mod. C+L+S

Cylinders Series 90

N.B. : the single-acting cylinders, sizes L and R1 are increased by 25 mm.



+ = add the stroke

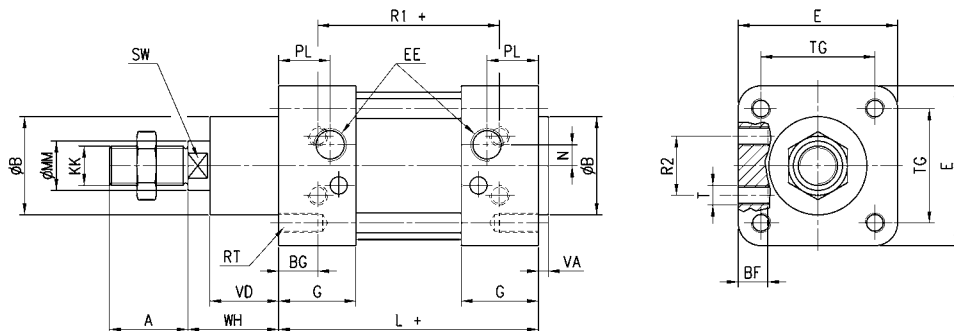

DIMENSIONS

∅	A	B	BF	BG	E	EE	G	KK	L	MM	N	PL	RT	R1	R2	SW	T	TG	VA	VD	WH
32	22	30	10	16	47	G1/8	28	M10x1,25	94	12	4,5	14	M6	64	16	10	M5	33	4	20	26
40	24	35	10	16	53	G1/4	32	M12x1,25	105	16	5,5	16	M6	70	21	13	M6	38	4	22	30
50	32	40	12	16	65	G1/4	32	M16x1,5	106	20	8,5	21	M8	74	24	17	M8	46,5	4	28	37
63	32	45	12	16	75	G3/8	35	M16x1,5	121	20	8,5	22	M8	85	33	17	M8	56,5	4	28	37
80	40	45	15	16	95	G3/8	36	M20x1,5	128	25	8,5	23	M10	92	34	21	M10	72	4	34	46
100	40	55	15	16	115	G1/2	41	M20x1,5	138	25	10	26	M10	100	58	21	M10	89	4	38	51
125	54	60	24	20	140	G1/2	45	M27x2	160	32	12,5	30	M12	110	65	27	M12	110	5	50	65

Cylinders Series 90

Through rod

N.B. : the single-acting cylinders, sizes L, R1 and ZM are increased by 25 mm.



+ = add the stroke
++ = add the stroke two times

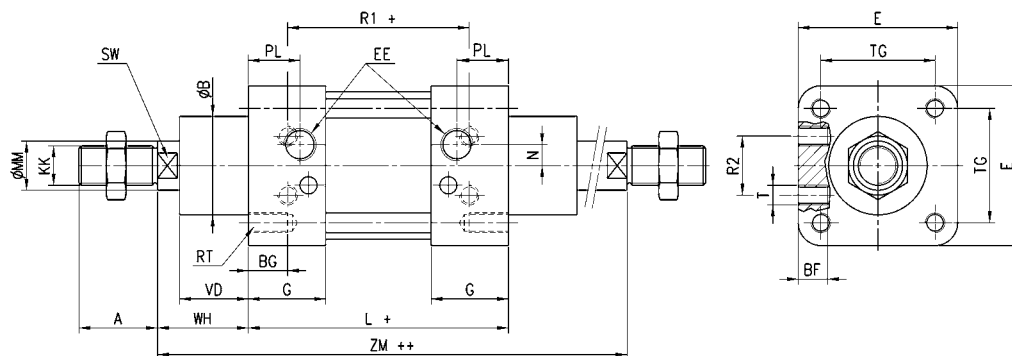

DIMENSIONS

∅	A	B	BF	BG	E	EE	G	KK	L	MM	N	PL	RT	R1	R2	SW	T	TG	VD	WH	ZM
32	22	30	10	16	47	G1/8	28	M10x1,25	94	12	4,5	14	M6	64	16	10	M5	33	20	26	146
40	24	35	10	16	53	G1/4	32	M12x1,25	105	16	5,5	16	M6	70	21	13	M6	38	22	30	165
50	32	40	12	16	65	G1/4	32	M16x1,5	106	20	8,5	21	M8	74	24	17	M8	46,5	28	37	180
63	32	45	12	16	75	G3/8	35	M16x1,5	121	20	8,5	22	M8	85	33	17	M8	56,5	28	37	195
80	40	45	15	16	95	G3/8	36	M20x1,5	128	25	8,5	23	M10	92	34	21	M10	72	34	46	220
100	40	55	15	16	115	G1/2	41	M20x1,5	138	25	10	26	M10	100	58	21	M10	89	38	51	240
125	54	60	24	20	140	G1/2	45	M27x2	160	32	12,5	30	M12	110	65	27	M12	110	50	65	290

Foot mount Mod. B

Material: stainless steel 304.
The following is supplied: 2x feet 4x screws



Supplied with:
2x feet
4x screws
+ = add the stroke

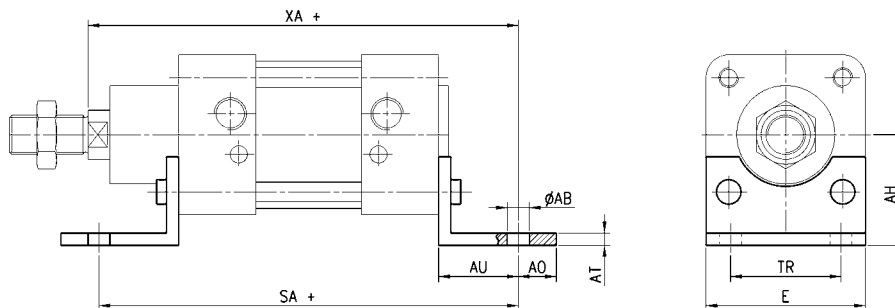

DIMENSIONS

Mod.	∅	AB	AH	AO	AT	AU	E	TR	SA	XA
B-90-32	32	7	32	11	4	24	45	32	142	144
B-90-40	40	9	36	8	4	28	52	36	161	163
B-90-50	50	9	45	15	5	32	65	45	170	175
B-90-63	63	9	50	13	5	32	75	50	185	190
B-90-80	80	12	63	14	6	41	95	63	210	215
B-90-100	100	14	75	16	6	41	115	75	220	230
B-90-125	125	16	90	25	8	45	140	90	250	270

Front and rear flange Mod. D

Material: stainless steel 304.



Supplied with:
1x flange
4x screws
+ = add the stroke

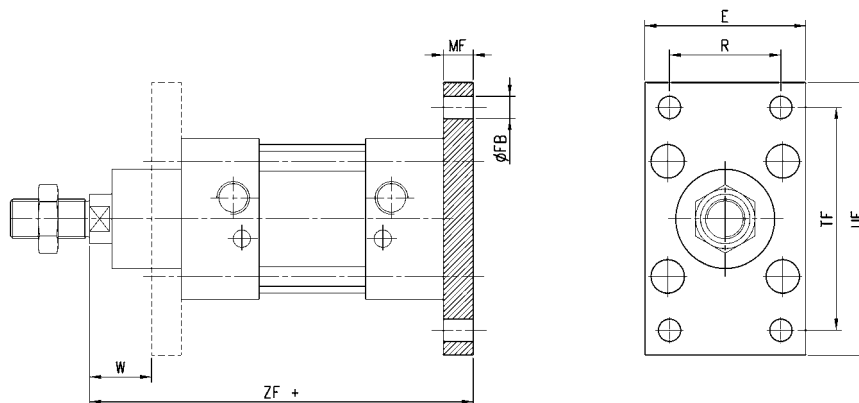

DIMENSIONS

Mod.	∅	E	FB	MF	TF	UF	W	ZF	R
D-E-90-32	32	45	7	10	64	80	16	130	32
D-E-90-40	40	52	9	10	72	90	20	145	36
D-E-90-50	50	65	9	12	90	110	25	155	45
D-E-90-63	63	75	9	12	100	120	25	170	50
D-E-90-80	80	95	12	16	126	150	30	190	63
D-E-90-100	100	115	14	16	150	170	35	205	75
D-E-90-125	125	140	16	20	180	205	45	245	90

Rear trunnion, female Mod. C

Material: stainless steel 304.



Supplied:
1x female trunnion
4x screws

+ = add the stroke

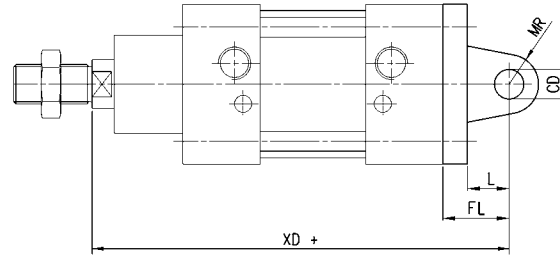
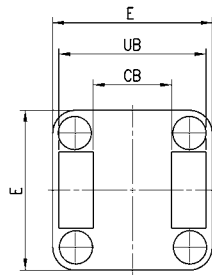

DIMENSIONS

Mod.	∅	CB	CD	E	FL	L	MR	UB	XD
C-H-90-32	32	26	10	45	22	12	10	45	142
C-H-90-40	40	28	12	52	25	15	12	52	161
C-H-90-50	50	32	12	65	27	17	12	60	170
C-H-90-63	63	40	16	75	32	20	16	70	185
C-H-90-80	80	50	16	95	36	22	16	90	210
C-H-90-100	100	60	20	115	41	25	20	110	230
C-H-90-125	125	70	25	140	50	30	25	130	275

Rear trunnion, male Mod. L

Material: stainless steel 304.



Supplied:
1x male trunnion
4x screws

+ = add the stroke

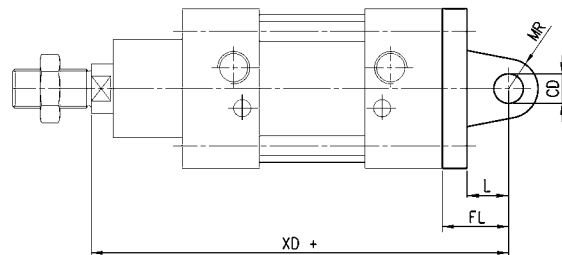
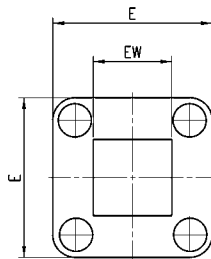

DIMENSIONS

Mod.	∅	EW	CD	E	FL	L	MR	XD
L-90-32	32	26	10	45	22	12	10	142
L-90-40	40	28	12	52	25	15	12	161
L-90-50	50	32	12	65	27	17	12	170
L-90-63	63	40	16	75	32	20	16	185
L-90-80	80	50	16	95	36	22	16	210
L-90-100	100	60	20	115	41	25	20	230
L-90-125	125	70	25	140	50	30	25	275

Combination Mod. C+L+S

Material: stainless steel 304

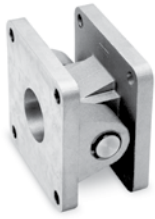

+ = add the stroke

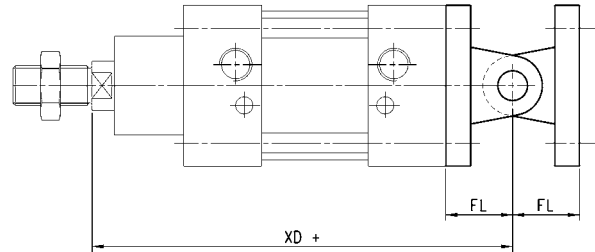
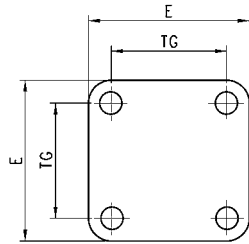

DIMENSIONS

Mod.	∅	E	FL	L	TG	XD
C+L+S	32	45	22	12	33	142
C+L+S	40	52	25	15	38	161
C+L+S	50	65	27	17	47	170
C+L+S	63	75	32	20	57	185
C+L+S	80	95	36	22	72	210
C+L+S	100	115	41	25	89	230
C+L+S	125	140	50	30	110	275

90° male trunnion Mod. ZC

Material: stainless steel 304



Supplied with:
1x male support

+ = add the stroke

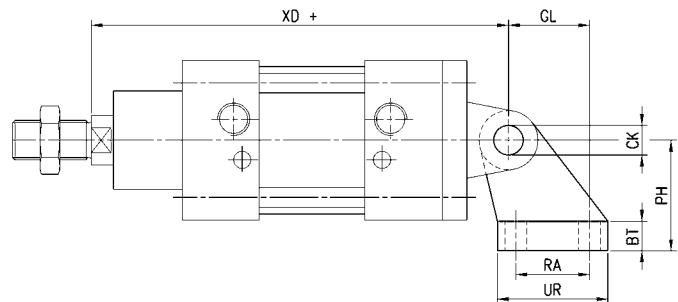
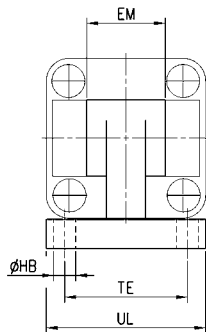

DIMENSIONS

Mod.	∅	BT	CK	EM	GL	HB	PH	RA	TE	UL	UR	XD
ZC-90-32	32	8	10	26	21	6,6	32	18	38	51	31	142
ZC-90-40	40	10	12	28	24	6,6	36	22	41	54	35	161
ZC-90-50	50	12	12	32	33	9	45	30	50	65	45	170
ZC-90-63	63	14	16	40	37	9	50	35	52	67	50	185
ZC-90-80	80	14	16	50	47	11	63	40	66	86	60	210
ZC-90-100	100	17	20	60	55	11	71	50	76	96	70	230
ZC-90-125	125	20	25	70	70	14	90	60	94	124	90	275

Rod fork end Mod. G-90

Material: stainless steel 303
ISO 8140

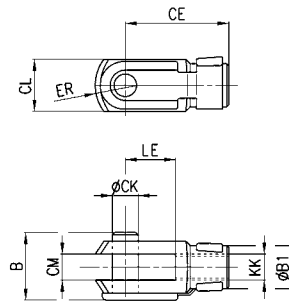

DIMENSIONS

Mod.	\emptyset	CK	LE	CM	CL	ER	CE	KK	B	B1
G-90-25-32	32	10	20	10	20	12	40	M10x1,25	26	18
G-90-40	40	12	24	12	24	14	48	M12x1,25	32	20
G-90-50-63	50-63	16	32	16	32	19	64	M16x1,5	40	26
G-90-80-100	80-100	20	40	20	40	25	80	M20x1,5	48	34
G-90-125	125	30	55	30	55	38	110	M27x2	74	48

Clevis pin Mod. S-90

Material: stainless steel 303

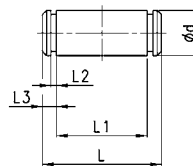

DIMENSIONS

Mod.	\emptyset	d	L	L1	L2	L3
S-90-32	32	10	53	46	1,1	3
S-90-40	40	12	60	53	1,1	3
S-90-50	50	12	68	61	1,1	3
S-90-63	63	16	78	71	1,1	3
S-90-80	80	16	98	91	1,1	3
S-90-100	100	20	118	111	1,3	5
S-90-125	125	25	139	132	1,3	4,2

Swivel ball joint Mod. GA-90

Material: stainless steel 304
ISO 8139

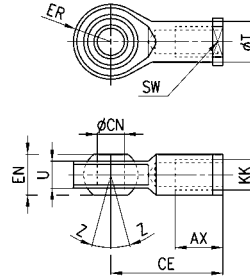

DIMENSIONS

Mod.	\emptyset	CN	U	EN	ER	AX	CE	KK	T	Z	SW
GA-90-32	32	10	10,5	14	14	20	43	M10x1,25	15	6,5	17
GA-90-40	40	12	12	16	16	22	50	M12x1,25	17,5	6,5	19
GA-90-50-63	50-63	16	15	21	21	28	64	M16x1,5	22	7,5	22
GA-90-80-100	80-100	20	18	25	21	33	77	M20x1,5	27,5	7	30
GA-90-125	125	30	25	35	35	51	110	M27x2	40	7,5	41

Piston rod lock nut Mod. U-90

Material: stainless steel 304
UNI 5589

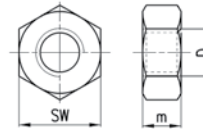

DIMENSIONS

Mod.	\emptyset	D	m	SW
U-90-25-32	32	M10x1,25	6	17
U-90-40	40	M12x1,25	7	19
U-90-50-63	50-63	M16x1,5	8	24
U-90-80-100	80-100	M20x1,5	9	30
U-90-125	125	M27x2	12	41